

PYLE

PL97M4

USER`S MANUAL

Car Stereo System

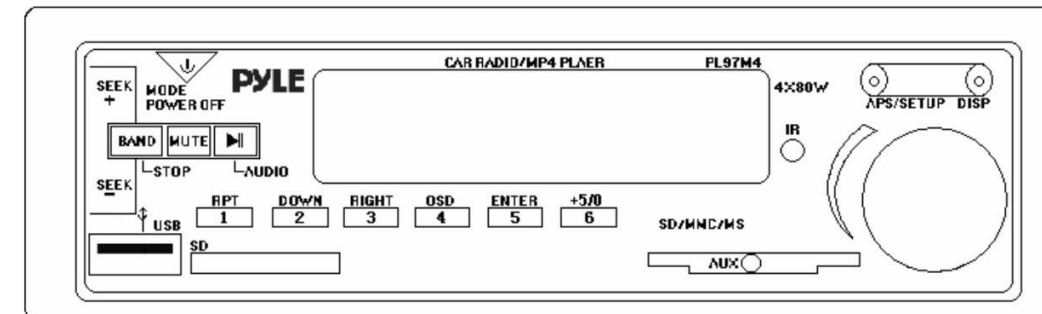

- Fixed Panel
- Car Radio With USB/SD/AUX In Player
- AM/FM PLL Stereo Receiver
- Compatible With MP3/WMA/MP4
- USB/SD Direct Playback

www.pyleaudio.com

Specification

Supply voltage	12V DC		
Current consumption	Less than 10A		
Video signal output	1.0Vp-p, 75 Ω		
Audio signal output	4X80W		
Characteristics	(1) frequency response: 20Hz-20 kHz		
	(2) S/N ratio: 90dB (JIS)		
	(3) Wow and flutter: Below measurable limits		
	For 3 bands (Europe) FM	For 2 bands (Europe) FM	For 2 bands (U.S.A) FM
Frequency coverage	87.5 to 108 MHz	87.5 to 108MHz	87.5 to 107.9 MHz
IF	10.7 MHz	10.7 MHz	10.7 MHz
Sensitivity(S/N=30dB)	15dBu	15dBu	15dBu
	MW	MW	MW
Frequency coverage	522 to 1620 kHz	522 to 1620 kHz	530 to 1710 kHz
IF	450 kHz	450 kHz	450 kHz
Sensitive (S/N=20dB)	40 dBu	40 dBu	40 dBu
	LW (Optional)		
Frequency coverage	144 to 290 kHz		
IF	450 kHz		
Sensitivity (S/N=20dB)	45 dBu		

NOTE:
Due to improvements in technology, specifications and design are subject to modification, without notice.

CONTENTS

1. Precautions	1
2. WARNING	1
3. Installation & Maintenance	2
4. Wiring Connection Diagram	4
5. Front Panel Diagram	4
6. Function Of The Unit Front Panel	5
7. Remote Controller Diagram	6
8. Function Of The Remote Controller	6
9. Basic Operation	7
10. Radio Operation	8
11. USB/CARD Operation	9
12. System Setup	10
13. System Setup Default Table	14
14. Common Trouble Shooting	14
15. Specification	15

Precautions

1. This product is designed to operate with a 12V car DC battery. Higher or lower voltage may affect the normal performance of the unit, even damage the unit.
2. Please connect the unit according to the installation instruction. Incorrect connection may cause troubles to the player or damage the electrical system.
3. Before turn on the POWER of the unit, make sure that the unit is connected properly.
4. To replace the damaged fuse, be sure to use the fuse of the rating prescribed on the unit only.
5. Do not block the intake or radiator board, in order to avoid player overheating.
6. Do not attempt to disassemble or modify this product, otherwise it may cause trouble.
7. Stop the car before performing any complicated operation.
8. Do not play this product in too high or too low temperature. The proper temperature is from -20 to 80, in which the player can run normally.



WARNING

- It is forbidden to watch video while driving.
- For maintenance of the unit, please turn off the POWER of the unit before lock your car.

System Setup Default Table

Default parameters of the System setting:

GENERAL SETUP PAGE	OSD LANG	ENGLISH
	TV TYPE	NTSC
	TV DISPLAY	4:3 PS
	MP3 MODE	AUTO
	DEFAULT	--
VIEDEO SETUP PAGE	SHARPNESS	LOW
	BRIGHTNESS	00
	CONTRAST	00

Common Trouble Shooting

If meet trouble, check wiring connection before looking through the check table. If any troubles are out of the check table, please consult your nearest dealer for service.

Symptom	Cause	Solution
No power.	The car ignition is not on.	If the power supply is properly connected to the car accessory terminal, switch the ignition key to "ACC".
	The fuse is blown.	Replace the fuse.
No sound.	Volume is in minimum.	Adjust volume to desired level.
	Wiring is not properly connected.	Check wiring connection, and correct it.
Radio doesn't work.	The antenna cable is not properly connected.	Insert the cable firmly.
Radio can't search stations automatically.	The signal is too weak.	Search stations manually.
The unit can't playback automatically.	The MP3 MODE is set as MANUAL.	Enter the System Setup Menu, set the MP3 MODE as AUTO.

5. DEFAULT:

It is used to load the factory setting. The diagram of the setting is as follow:

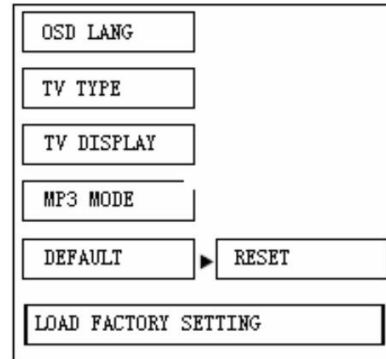

VIDEO SETUP PAGE:

1. SHARPNESS:

It is used to set the sharpness level of the picture as one of the three levels: HIGH, MEDIUM, and LOW. The diagram of the setting is as follow:

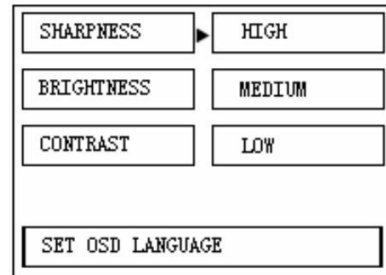

2. BRIGHTNESS:

It is used to set the brightness of the picture. When you use the cursor buttons to select the sub-menu—BRIGHTNESS, the corresponding setting picture shows. The diagram of the setting picture is as follow:



Use the ←→ on the remote controller to adjust the brightness to your desired level, and then press ► to return.

3. CONTRAST:

It is used to set the contrast of the picture. When you use the cursor buttons to select the sub-menu—CONTRAST, the corresponding setting picture shows. The diagram of the setting picture is as follow:

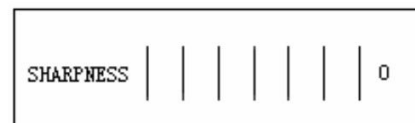

Use the ≡ on the remote controller to adjust the contrast to your desired level, and then press ► to return.

Installation & Maintenance

This unit can be properly installed either from “Front” or “Rear”. For details, refer to the following illustrated installation methods.

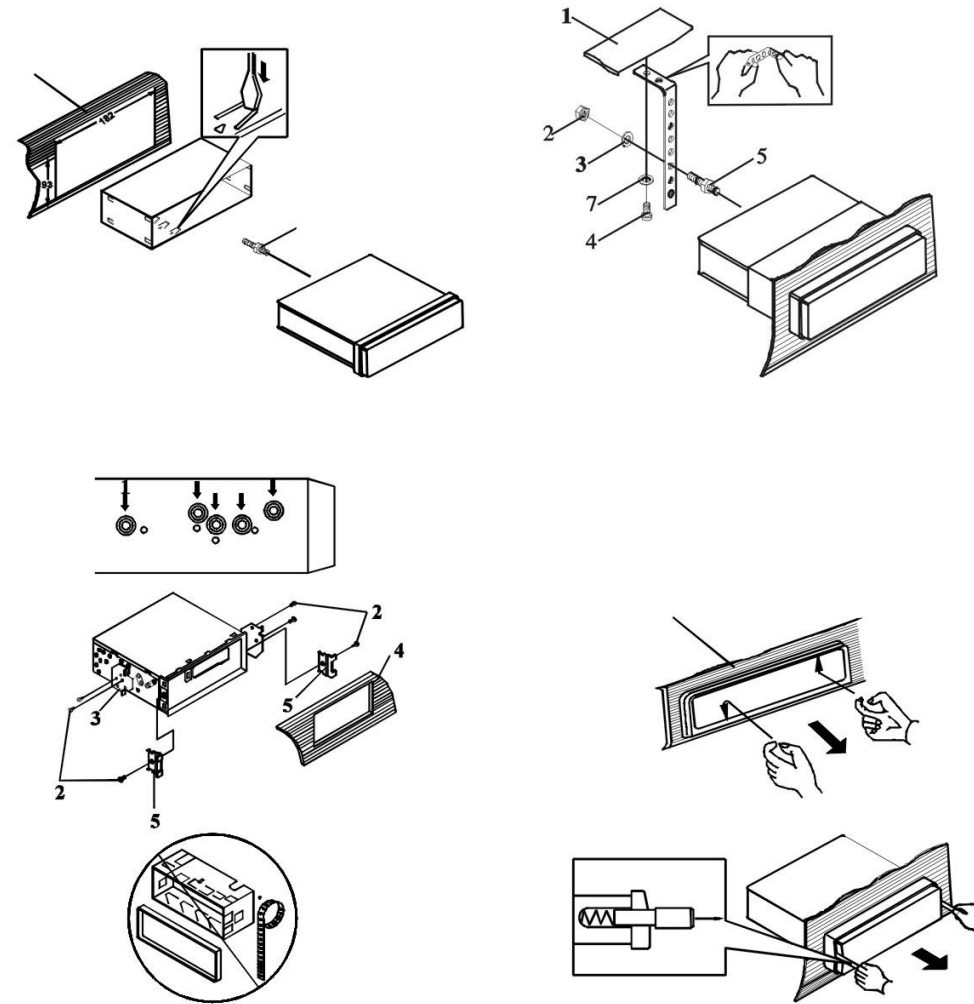

DIN FRONT-MOUNT (Method A)

1. Dashboard
2. Holder.

After inserting the holder into the dashboard, select the appropriate tab according to the thickness of the dashboard material and bend them inwards to secure the holder in place.

3. Screw

Parts used:

1. Dashboard
2. Nut (5mm)
3. Spring washer
4. Screw (5 x 25mm)

5. Screw
6. Strap
Be sure to use the strap to secure the back of the unit in place. The strap can be bent by hand to the desired angle.
7. Plain washer

DIN REAR-MOUNT (Method B)

Installation using the screw holes on the sides of the unit.

1. Frame
2. Insert fingers into the groove in the front of frame and pull out to remove the frame.
3. Lever
Insert the levers supplied with the unit into the grooves at both sides of the unit as shown in figure until they click. Pulling the levers makes it possible to remove the unit from the dashboard.

Fasten the unit to the factory radio mounting bracket.

1. Select a position where the screw holes of the bracket and the screw holes of the main unit become aligned and tighten the screws at 2 places on each side. Use either truss screws (5 x 5mm) or flush surface screws (4 x 5mm), depending on the shape of the screw holes in the bracket.
2. Screw
3. Factory radio mounting bracket
4. Dashboard or Console
5. Hook (Remove this part)

NOTE:

1. Only qualified and authorized service personnel can install this player, to avoid damaging your car, please consult the dealer when you install this product.
2. Do not try to maintain this player yourself, if you meet trouble, just consult the dealer, and leave the task to the qualified service personnel.

- b. 4:3 LB:
Play in LETTER BOX style. In this case, there will be black band appear on the bottom and top of the screen, if connected to a wide-screen TV.
- c. 16:9 WIDE:
Select it if you connect this unit to a wide-screen TV.

The diagram of the setting is as follow:

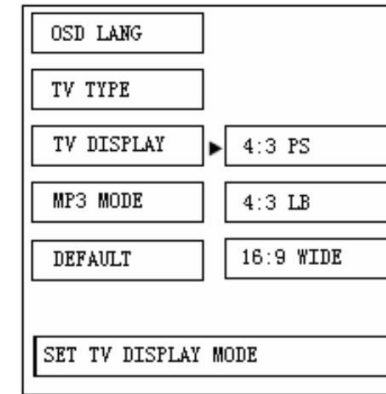

4. MP3 MODE:
It is used to set the MP3 MODE as AUTO or MANUAL. The diagram of the setting is as follow:
 - a. AUTO MODE:
The unit distinguishes the audio/video files automatically, and groups them by type in the same play list (root folder) newly. In this mode, the unit can playback automatically.
 - b. MANUAL MODE:
The unit doesn't group the audio/video files newly, but show the original audio/video files you loaded into the USB/SD CARD. E.g. audio files, video files, and folders containing audio/video files.

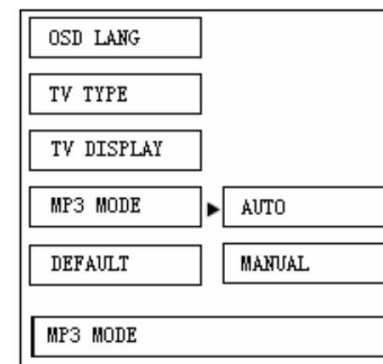

It includes two main sub-setting pages: GENERAL SETUP PAGE and VIDEO SETUP PAGE. The former has some general settings included, such as OSD LANG, TV TYPE, TV DISPLAY, MP3 MODE, and DEFAULT. The latter is used to set video parameters, including SHARPNESS, BRIGHTNESS, and CONTRAST. For details, please refer to the following corresponding introduction.

GENERAL SETUP PAGE:

1. OSD LANG:

It is used to set your desired system language. The diagram of the setting is as follow:

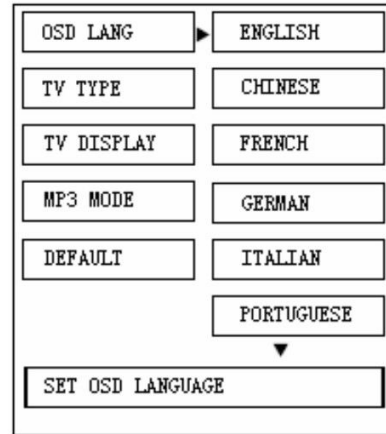

2. TV TYPE:

It is used to set the TV standard. This player can play video recorded in NTSC and PAL format. You can set it as NTSC or PAL format according to the TV system. Also you can select AUTO to let the unit set the type automatically. The diagram of the setting is as follow:

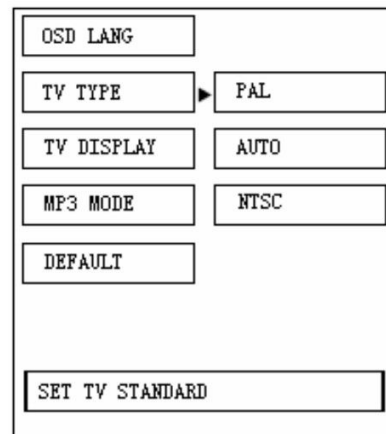

3. TV DISPLAY:

It is used to set the TV display mode. You can set it as one of the following three modes according to your TV set.

a. 4:3 PS:

Play in the PAN&SCAN style. In this case, the left and right edges of the screen will be cut off, if connected to a wide-screen TV.

Wiring Connection Diagram

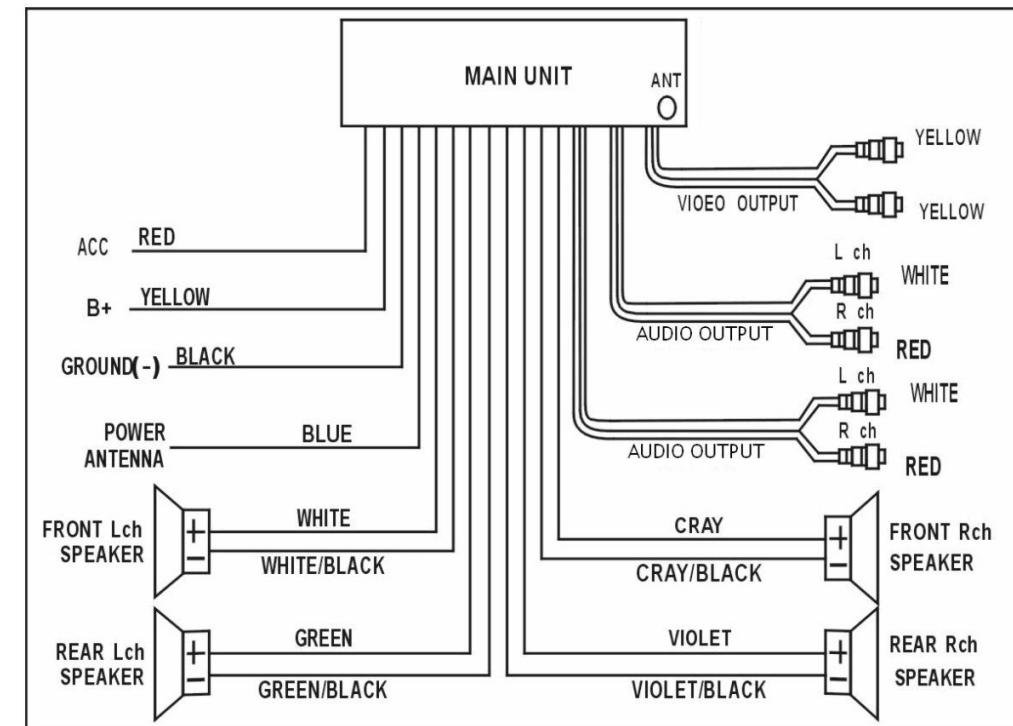

Front Panel Diagram

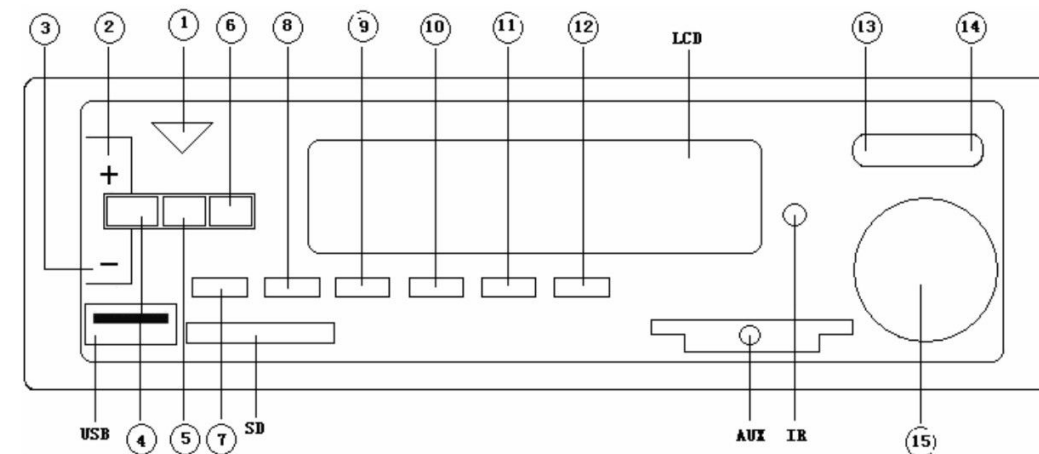

Function Of The Unit Front Panel

Button	Function
1. POWER/MODE	Power switch/mode switch.
2. SEEK+	Search the next radio station manually or automatically in radio mode; select next item of the same type (audio/video) as the current one to play or speed up playing the current track or video forward in USB/CARD mode; when in system setup state, used to select sub-menu downward/rightward.
3. SEEK-	Search the previous radio station manually or automatically in radio mode; select previous item of the same type (audio/video) as the current one to play or speed up playing the current track or video backward in USB/CARD mode; when in system setup state, used to select sub-menu upward/ leftward.
4. BAND/STOP	Station band selection in radio mode; stop playing the current track or video in USB/CARD mode.
5. MUTE	Short press, turn off the audio output; long press for more than two seconds, used to switch the audio output to mono/stereo in radio mode, and in USB/CARD mode, used to switch the audio output to l-mono/r-mono/stereo/mix-mono.
6. PAUSE/PLAY	Pause and resume playing in USB/CARD mode.
7. 1/RPT	Select the radio station stored in memory 1 or store the current station in memory 1 in radio mode; select the first item to play or press it for repeating the current playing item in USB/CARD mode.
8. 2/DOWN	Select the radio station stored in memory 2 or store the current station in memory 2 in radio mode; select the second item to play or used to select the sub-menu downward in system setup in USB/CARD mode.
9. 3/RIGHT	Select the radio station stored in memory 3 or store the current station in memory 3 in radio mode; select the third item to play or used to select the sub-menu rightward in system setup in USB/CARD mode.
10. 4/OSD	Select the radio station stored in memory 4 or store the current station in memory 4 in radio mode; select the forth item to play or used to display the message of the current playing item on screen in USB/CARD mode.
11. 5/ENTER	Select the radio station stored in memory 5 or store the current station in memory 5 in radio mode; select the fifth item to play or used to confirm the selection of the setting in system setup in USB/CARD mode.
12. 5/0	Select the radio station stored in memory 6 or store the current station in memory 6 in radio mode; select the item increasingly by five relatively to current playing item number or used to enter

3. Repeat Play And Message Display

Press the REPT on the remote controller or long press the 1/RPT on the front panel for more than two seconds, the unit will switch the repeat play mode to REPEAT ALL or REPEAT TRACK, or exit repeat play. Long press the 4/OSD on the front panel for two seconds to display the state message of the current playing item on the screen.

The following is the diagram of the picture on the screen while playing audio item.

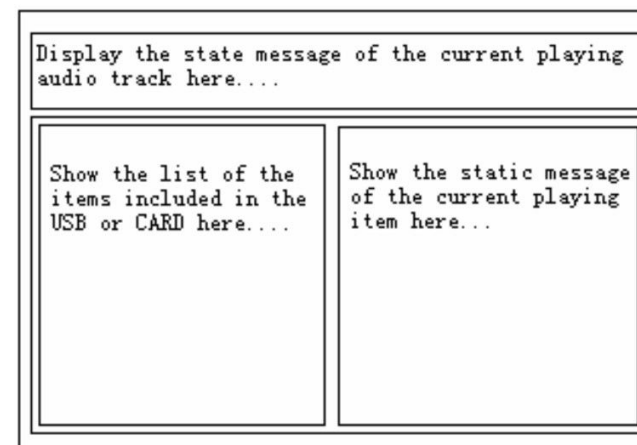

System Setup

Short press the SETUP on the remote controller or press the ASP/SETUP on the front panel to enter system setup menu, while in USB/CARD mode. You can either long press the cursor buttons (2/DOWN, 3/RIGHT) on the front panel or short press the cursor buttons (⏮, ⏭) on remote controller to select the sub-menu included in the system setup menu, and then long press the confirm button (5/ENTER) on the front panel or short press the confirm button (▶) on the remote controller to confirm the selected setting and exit system setting.

When you enter system setup menu, the diagram of the first picture shown to you is as follow:

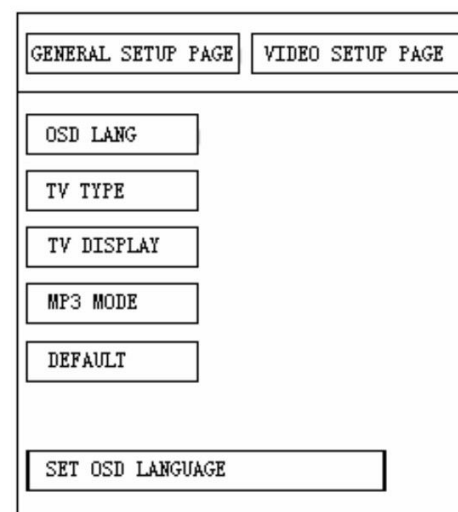

strongest level are preset to the corresponding preset number automatically.

2. Station Selection And Storage

- a. Short press number buttons (1~6) on either the front panel or the remote controller to select corresponding station stored in memory (1~6).
- b. Long press number buttons (1~6) on either the front panel or the remote controller to store the frequency of the current station into corresponding memory (1~6).

USB/CARD Operation

Following operations are in USB/CARD mode.

1. Item Selection And Play/Pause/Stop

- a. Short press ◀▶ on the remote controller to select the previous/next item of the same type (audio/video) as the current one to play. Also you can use ⏪ ⏩ button on the remote controller to select your desired item and press ▶ to play. Moreover, short press the SEEK+/SEEK- buttons on the front panel can serve the same purpose.
- b. Long press ◀▶ on the remote controller for more than two seconds to speed up playing current item backward/forward. Press ▶ to return to the normal play. There are six kinds of play speed, which include 1x (normal play speed), 2x,4x,8x,16x,32x. Moreover, long press the SEEK+/SEEK- buttons on the front panel for more than two seconds can serve the same purpose.
- c. Press ▶ on the remote controller to make the current play pause, and press it again to resume current play. Press ROOT button to stop the current play, and return to the root menu—play list, which is important if you want to return to play list while playing the video.
- d. Press GOTO button on the remote controller once, and then enter the number of your desired item, the unit will play the item in two seconds; if you press the GOTO button twice, and then enter the offset time you want. The unit will begin the current item play at the offset time.
- e. Select the item whose number is larger than “5” to play, by using the number buttons on the front panel. Short press 5/0 button, then short press one of the number buttons (1~5) to select the item whose number is “6~10”, respectively. Specially, if want to select the twentieth item to play, you can short press the number button 2, and then long press the 5/0 button for more than two seconds.
- f. Some else buttons on the front panel are of item selection function, as stated in **Function Of The Unit Front Panel** table.

2. Switch Play Between Audio And Video

While playing the audio file, press ↑ ↓ to select the video file, and then press ▶ to play it; while playing the video file, first press the ROOT button on the remote controller to stop the current play and return to the play list, then use the same operation as the case stated above to select the audio file and make it play.

	number “0” in USB/CARD mode.
13. ASP/SETUP	Scan and hold every preset station for a few seconds or scan the station from the low frequency to high frequency, and store the six stations with the strongest signal in corresponding memory in radio mode; used to enter system setup menu in USB/CARD mode.
14. DISP	Used to display clock, adjust clock or set the time format (12/24).
15. SEL/EQ	Used for multi-function selection and audio effect selection. Also used for enable/disable the AUX IN function.

NOTE: for details, please refer to the corresponding operation in different mode, which is described in latter chapter.

Remote Controller Diagram

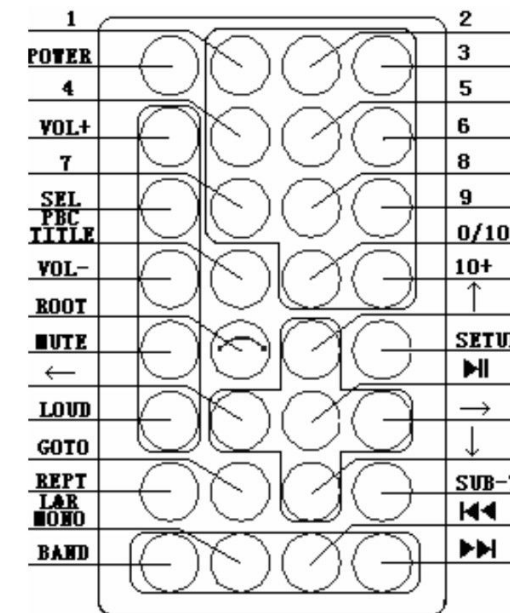

Function Of The Remote Controller

Button	Function
POWER	Refer to POWER/MODE (in Function Of The Unit Front Panel table).
0~9	Used to select your desired track or video to play by entering the item number.
VOL+	Used to turn up VOL/BAS/TRE/BAL/FAD, also you can use it to adjust the clock when setting the clock.
SEL	Refer to SEL/EQ (in Function Of The Unit Front Panel table).
VOL-	Used to turn down VOL/BAS/TRE/BAL/FAD, also you can use it to adjust the clock when setting the clock.

PBC/TITLE	No function.
10+	No function.
MUTE	Refer to MUTE (in Function Of The Unit Front Panel table).
ROOT	Used to stop the current playing item, and return to the root menu interface.
SETUP	Refer to ASP/SETUP (in Function Of The Unit Front Panel table), used in USB/CARD mode only.
↑↓←→	Used to select the sub menu upward/downward/leftward/rightward when in system setup; also you can use ↑↓ to select your desired item in the play list and then press ► to play in USB/CARD mode.
►	Pause/resume play, also can be used to confirm the selection of the setting when in system setup.
LOUD	Used to enable/disable super BASS effect output.
REPT	Used to set the repeat mode of the current playing item as Repeat Track mode or Repeat All mode.
GOTO	Used to select the desired item by entering the item number or select the starting play time relative to the beginning of the item by entering the offset time.
SUB-T	Used to select sub-title of DIVX format, if the video is of sub-title.
BAND	Used for station band selection in radio mode.
L/R MONO	In radio mode, used to switch the audio output mode between mono and stereo; during the playing of the video, used to switch the audio output mode among l-mono, r-mono, stereo, and mix-mono.
◀▶	Used to play the previous/next item of the same type (audio/video) as the current one, or speed up playing the current item backward/forward.

NOTE: for details, please refer to the corresponding operation in different mode, which is described in latter chapter.

Basic Operation

1. Turn On/off The Player

To turn on the unit, press any key on the front panel or press the POWER key on the remote controller. To turn off the unit, press the POWER key on either the front panel or remote controller for more than two seconds.

2. Volume Adjustment

Rotate right/left the SEL/EQ button on the front panel or press the VOL+/VOL- button on the remote controller to adjust the volume to your desired level.

3. Audio Effect Adjustment And AUX IN Mode Switch

Short press the SEL/EQ button constantly until the unit switch to the item you want (VOL/BAS/TRE/BAL/FAD/AUX IN), and then rotate the SEL/EQ button to adjust the level or to enable/disable the AUX IN function. Also you can obtain the same

effect by short pressing the SEL button on the remote controller, and then pressing the VOL+/VOL- similarly.

4. Audio Effect Selection

Long press the SEL/EQ button on the front panel for more than two seconds, the unit will switch the audio effect among Class, POP, and Rock.

5. Mode Switch

Short press the POWER/MODE button on either the front panel or the remote controller, switch the unit running mode among Radio, available AUX IN, USB and CARD.(NOTE: if can't switch to AUX IN mode, please enable the mode first. For detailed operation, refer to **Audio Effect Adjustment and AUX IN Mode Switch** stated above.)

6. Clock Display, Clock Adjustment And Time Format Switch

Short press the DISP button on the front panel, display the current clock. Short press it again to return to the former display.

Long press it for more than two seconds, enter the clock adjustment mode with the hour display flashing. Rotate the SEL/EQ button on the front panel or short press the VOL+/VOL- buttons on the remote controller to adjust the hour, short press the DISP button again to switch to minute setting with the minute display flashing. Similarly, use the SEL/EQ button on the front panel or the VOL+/VOL- buttons on the remote controller to adjust the minute, then short press DISP once more to exit clock setting. The unit restores the display before entering the clock setting.

When in clock adjustment state, long press DISP button for more than two seconds, the hour display flashes, long press it again, enter the time format(12/24) setting state.

7. Sound Channel Switch

Refer to the L/R MONO button introduction in the **Function Of The Remote Controller** table.

8. Picture Adjustment

For Picture adjustment and other settings, refer to the **System Setup** stated in latter chapter.

Radio Operation

Following operations are in Radio mode.

1. Station Search

- Short press the SEEK+/SEEK- on the front panel to search the previous/next station manually; long press them for more than two seconds to search the previous/next station automatically.
- Short press the APS button on the front panel, the radio searches every preset station automatically, and holds every preset station for a few seconds in order, respectively. Long press the button for more than two seconds, the radio searches stations from low frequency to high frequency, and checks the signal strength level until one cycle is finished. And then, six stations with the